

SCHEDULE									
SIZE	DEPTH	SPACE WIDTH	"A" DIM	"B" DIM	"C" DIM	"D" DIM	"E" DIM	CANT Front DIM	CANT Back DIM
9'x16'	16'	9'	7'	9'	9'	3'-6"	5'-6"	3'-6"	3'-6"
9'x18'	18'	9'	8'	10'	10'	4'	6'	4'	4'
9'x19'	19'	9'	8'-6"	10'-6"	11'	4'-6"	6'-6"	4'-6"	4'-6"
9'x20'	20'	9'	8'-3"	10'-9"	11'	4'-8"	6'-3"	4'-6"	4'-6"
10'x18'	18'	10'	8'	10'	10'	4'	6'	4'	4'

BAJA STANDARD	<b>BAJA</b> CONSTRUCTION CO., INC. 223 FOSTER ST., MARTINEZ CA 94553 1-800-366-9600 FAX: (925) 229-0161	SHEET
SINGLE POST (SP)		Page <u>1</u> of <u>1</u>

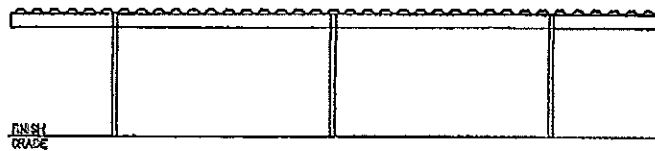
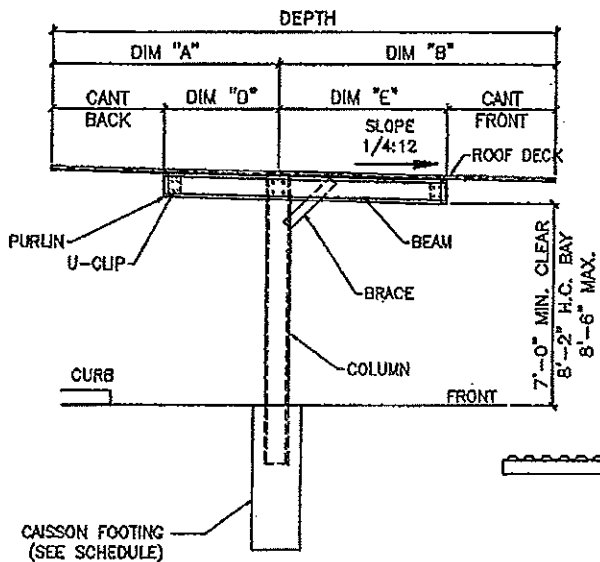
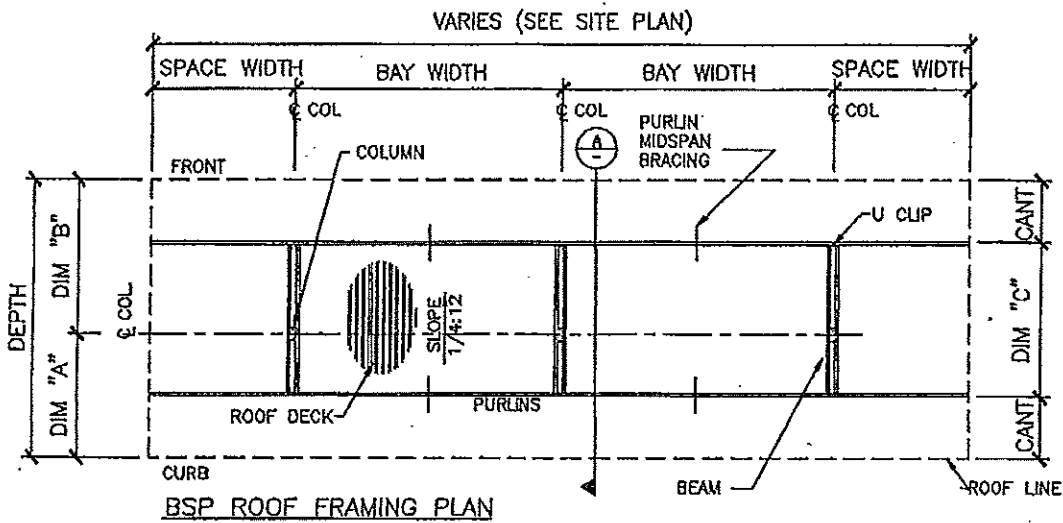

**SCHEDULE**

SIZE	DEPTH	SPACE WIDTH	"A" DIM	"B" DIM	"D" DIM	"D" DIM	"E" DIM	CANT Front DIM	CANT Back DIM
8'x18'	18'	8'	8'	10'	10'	4'	8'	4'	4'
9'x16'	16'	9'	7'	9'	9'	3'-6"	5'-6"	3'-6"	3'-6"
9'x18'	18'	9'	8'	10'	10'	4'	6'	4'	4'
9'x20'	20'	9'	9'-3"	10'-9"	11'	4'-9"	8'-3"	4'-6"	4'-6"
10'x18'	18'	10'	8'	10'	10'	4'	6'	4'	4'

<b>BAJA STANDARD</b>	<b>BAJA</b>	<b>SHEET</b>
<u>BSP (BRACED SINGLE POST) CARPORTS</u>	CONSTRUCTION CO., INC. 223 FOSTER ST., MARTINEZ CA 94553 1-800-366-8600 FAX: (925) 223-0181	Page <u>2</u> of <u>9</u>

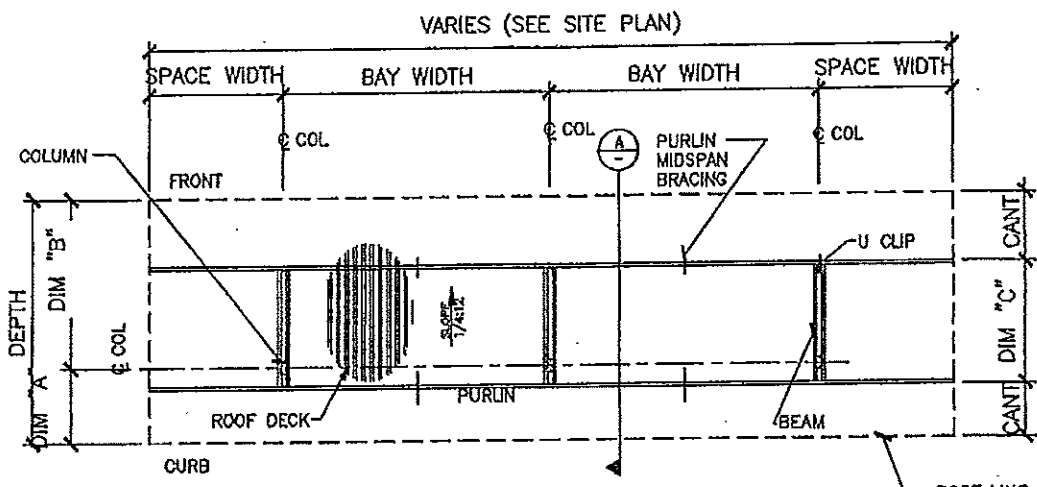

BSP 1/3 BACK ROOF FRAMING PLAN

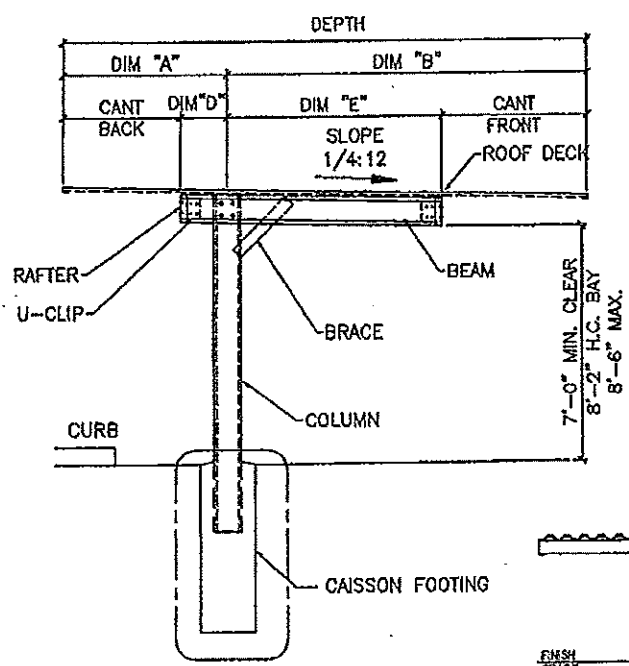

A CROSS SECTION

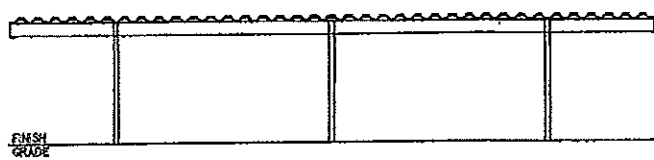

FRONT ELEVATION

SCHEDULE									
SIZE	DEPTH	SPACE WIDTH	"A" DIM	"B" DIM	"C" DIM	"D" DIM	"E" DIM	CANT Front DIM	CANT Back DIM
9'x18'	18'	9'	5'-7"	12'-5"	10'	2'-1"	7'-11"	4'-6"	3'-6"
9'x18'	16'	9'	4'-11"	11'-1"	8'	1'-5"	6'-7"	4'-6"	3'-6"

**BAJA STANDARD**  
 BSP BACK 1/3 (BRACED SINGLE POST-BACK 1/3) GARPORTS

**BAJA**  
 CONSTRUCTION CO., INC.  
 223 FOSTER ST., MARTINEZ CA 94553  
 1-800-368-9600 FAX: (925) 229-0161

**SHEET**  
 Page 3 of 9

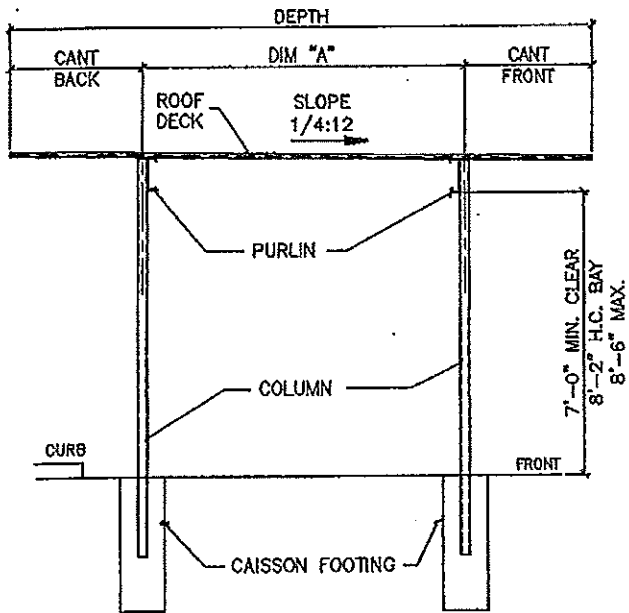
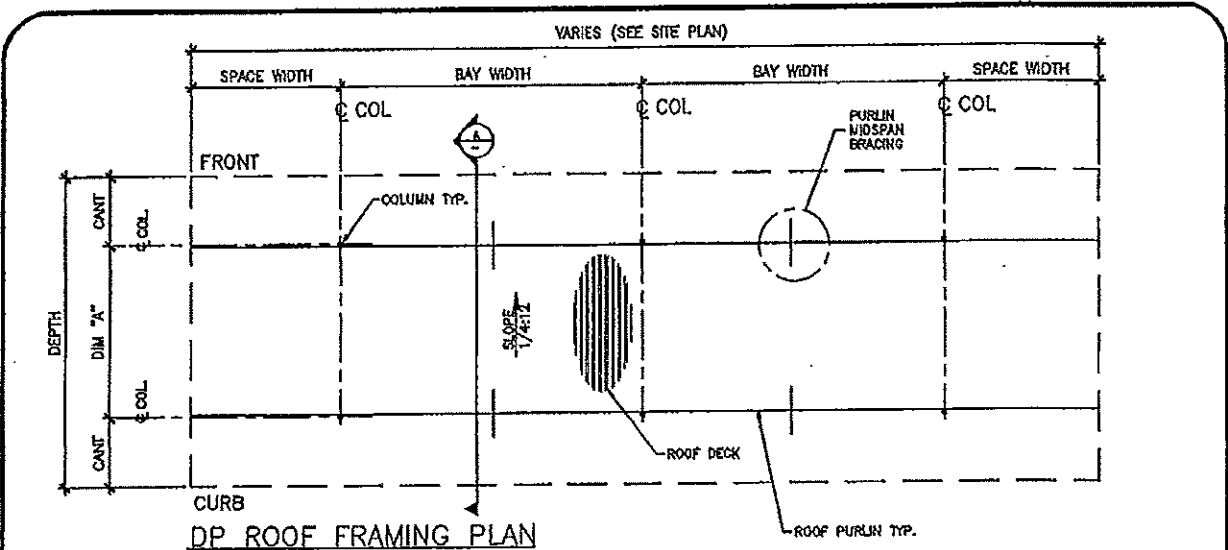

SCHEDULE						
SIZE	DEPTH	SPACE WIDTH	"A" DIM	CANT Front DIM	CANT Back DIM	
9'x18'	18'	9'	10'	4'	4'	
9'x20'	20'	9'	11'	4'-6"	4'-6"	
9.25'x18'	18'	9'-3"	10'	4'	4'	
10'x20'	20'	10'	11'	4'-6"	4'-6"	
10.5'x16'	16'	10'-6"	9'	3'-6"	3'-6"	

**A** DP CROSS SECTION

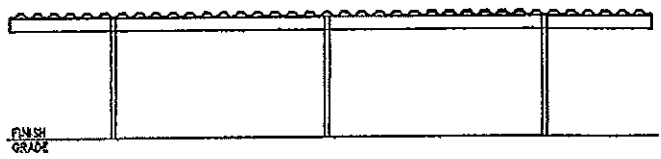

FRONT ELEVATION

<p><b>BAJA STANDARD</b></p> <p><b>DP (DOUBLE POST) CARPORTS</b></p>	<p><b>BAJA</b></p> <p><b>CONSTRUCTION CO., INC.</b></p> <p>223 FOSTER ST., MARTINEZ CA 94553</p> <p>1-800-368-9600 FAX: (925) 229-0161</p>	<p><b>SHEET</b></p> <p>Page <u>4</u> of <u>9</u></p>
---	--	--

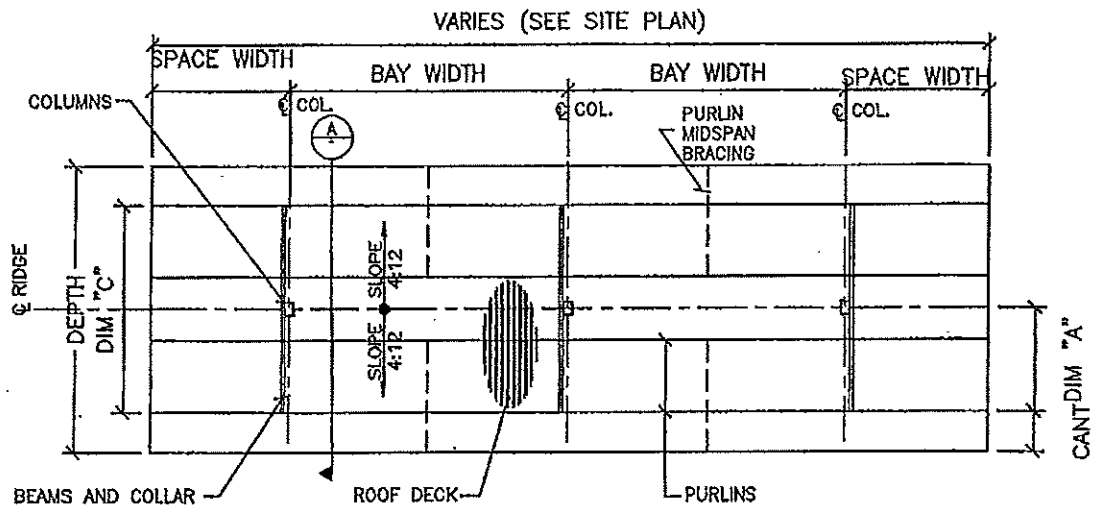

SP GABLE ROOF FRAMING PLAN

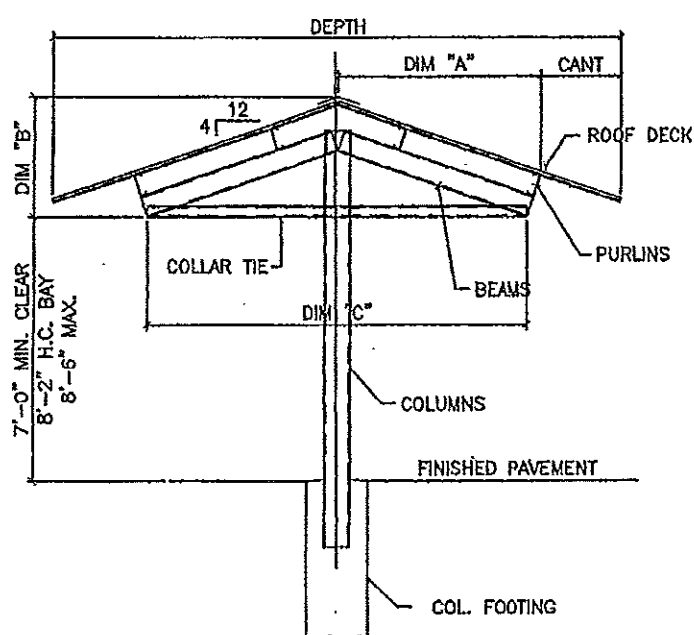

A SP GABLE CROSS SECTION

SCHEDULE						
SIZE	DEPTH	SPACE WIDTH	"A" DIM	"B" DIM	"C" DIM	CANT DIM
9'x18'	18'	9'	6'-6"	3'-8 3/4'	12'-1 7/8"	2'-6"

BAJA STANDARD  
 SP GABLE (SINGLE POST) W/METAL ROOF CARPORTS

**BAJA**  
 CONSTRUCTION CO., INC.  
 223 FOSTER ST., MARTINEZ CA 94553  
 1-800-366-9600 FAX: (925) 229-0161

SHEET  
 Page 5 of 9

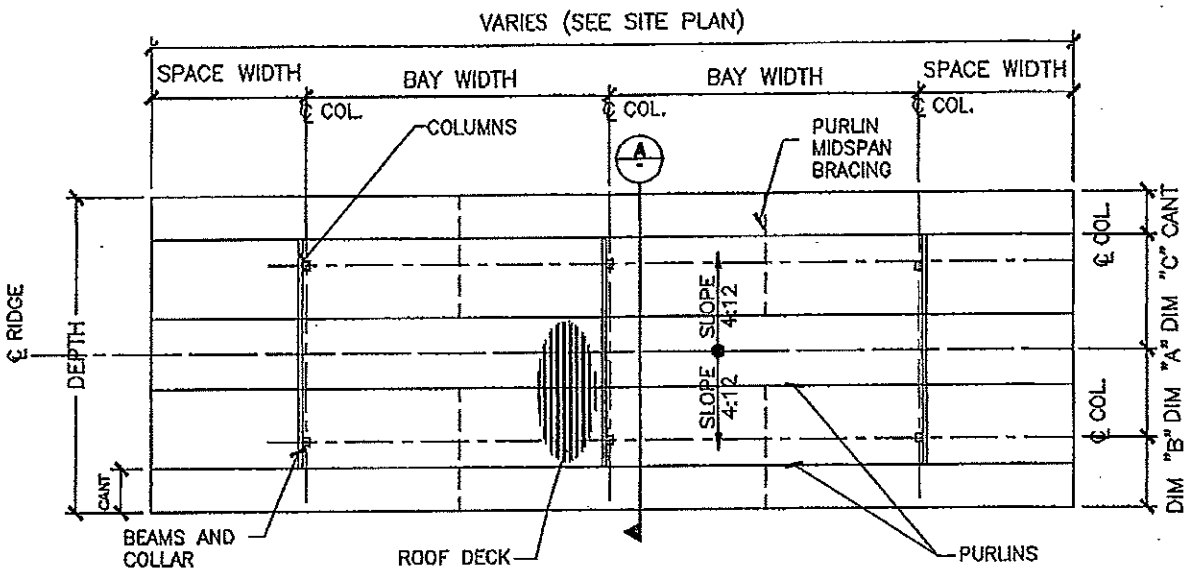

GABLE ROOF FRAMING PLAN

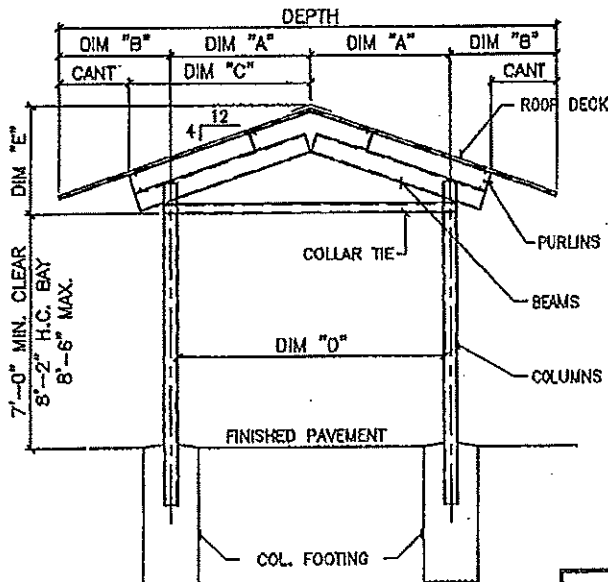

**A** GABLE CROSS SECTION

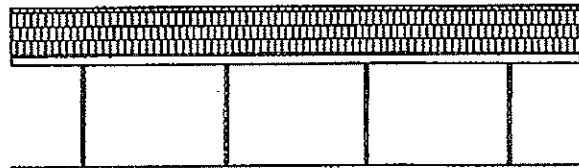

FRONT ELEVATION

SCHEDULE								
SIZE	DEPTH	SPACE WIDTH	"A" DIM	"B" DIM	"C" DIM	"D" DIM	"E" DIM	CANT DIM
9'x18'	18'	9'	5'	4'	6'-6"	9'-6"	3'-0 1/4"	2'-8"
10'x20'	20'	10'	6'	4'	7'-8"	11'-6"	4'-2 3/8"	2'-6"
10.25'x22'	22'	10'-3"	7'	4'	11'	13'-6"	4'-5 1/4"	4'-6"

BAJA STANDARD

GABLE W/METAL ROOF CARPORTS

**BAJA**

CONSTRUCTION CO., INC.  
223 FOSTER ST., MARTINEZ CA 94553  
1-800-368-9600 FAX: (925) 229-0161

SHEET

Page 6 of 9

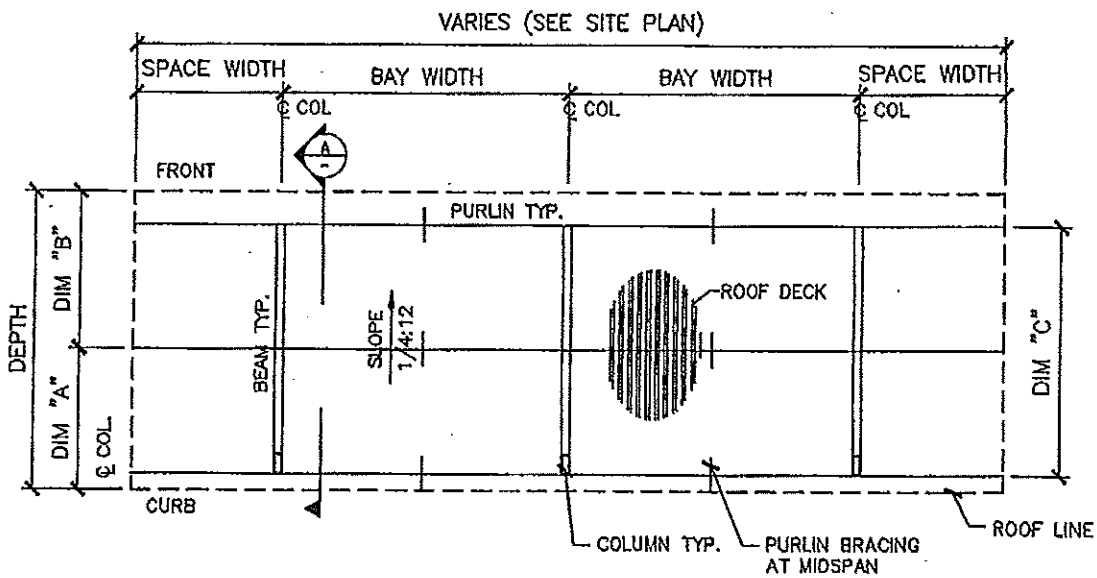

FULL CANT ROOF FRAMING PLAN

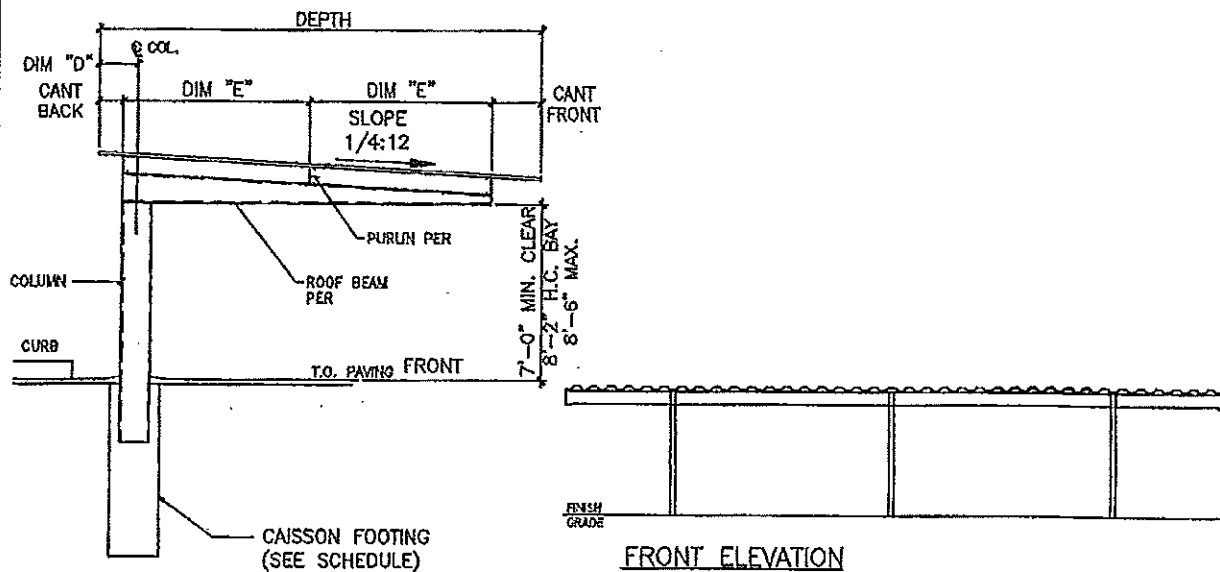

FRONT ELEVATION

(A) FULL CANT CROSS SECTION

SCHEDULE									
SIZE	DEPTH	SPACE WIDTH	"A" DIM	"B" DIM	"C" DIM	"D" DIM	"E" DIM	CANT Front DIM	CANT Back DIM
9'x18' CBC	18'	9'	7'-9 1/2"	10'-2 1/2"	13'-4"	1'-7"	6'-2 1/2"	4'-0"	1'-0"
9'x18' IBC	18'	9'	8'-6"	9'-6"	16'	1'-7"	7'-6"	2'-0"	1'-0"
9'x19'	19'	9'	8'-3 1/2"	10'-8 1/2"	14'-4"	1'-7"	6'-8 1/2"	4'	1'-0"

<b>BAJA STANDARD</b>	<b>BAJA</b> CONSTRUCTION CO., INC. 223 FOSTER ST., MARTINEZ CA 94553 1-800-366-9800 FAX: (925) 229-0181	<b>SHEET</b>
<b>FC (FULL CANT) CARPORTS</b>		Page <u>7</u> of <u>9</u>

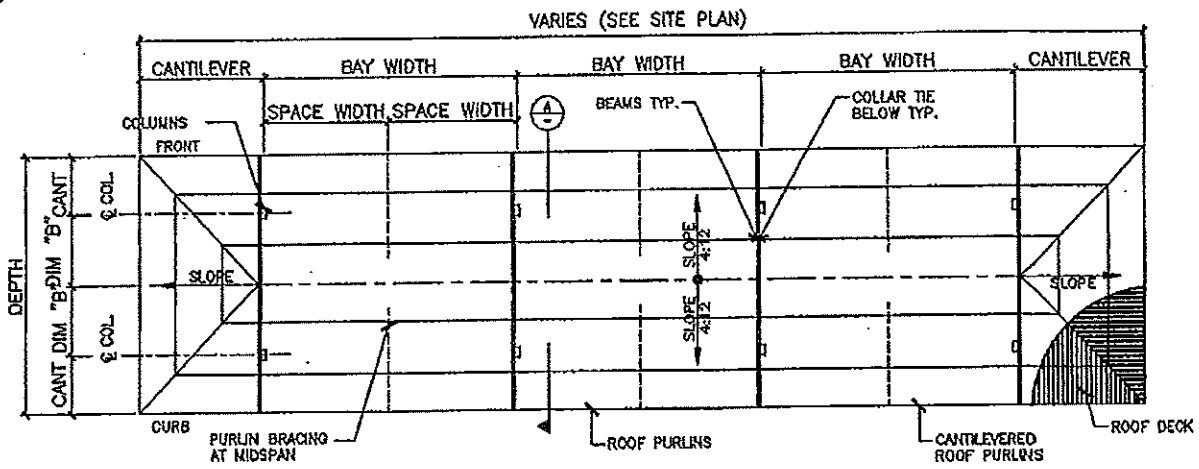

HR ROOF FRAMING PLAN

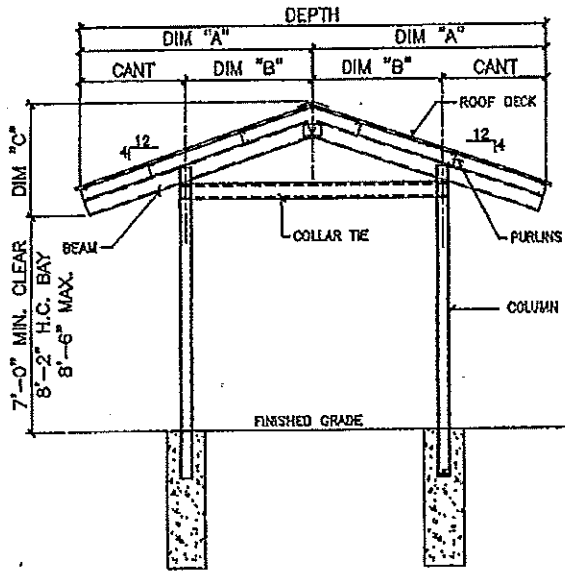

(A) CANOPY CROSS SECTION

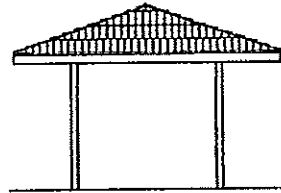

SIDE ELEVATION

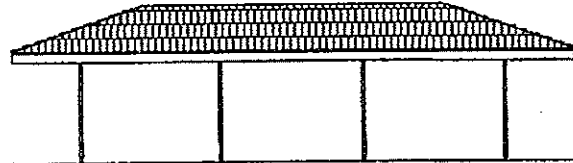

FRONT ELEVATION

SCHEDULE						
SIZE	DEPTH	SPACE WIDTH	"A" DIM	"B" DIM	"C" DIM	CANT Front DIM
10'x20'	20'	10'	10'	5'-6"	4'-8 1/4"	4'-6"

**BAJA STANDARD**

HR W/ METAL ROOF (HIP ROOF) CARPORTS

**BAJA**

CONSTRUCTION CO., INC.  
223 FOSTER ST., MARTINEZ CA 94553  
1-800-366-9600 FAX: (025) 229-0161

**SHEET**

Page 8 of 9



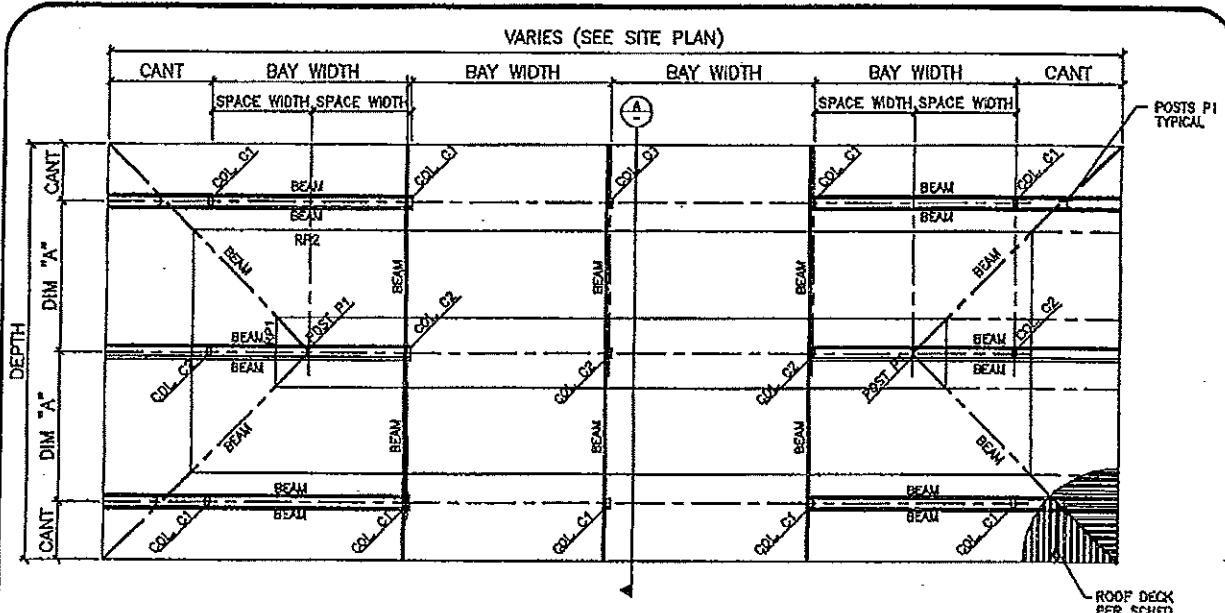

HR-BB ROOF FRAMING PLAN

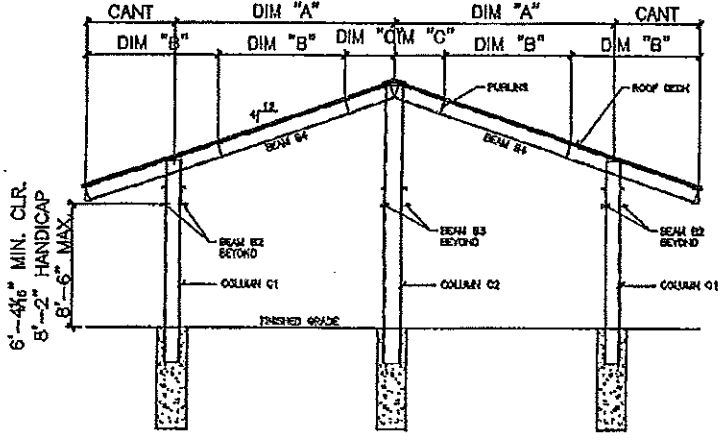

A HR-BB CROSS SECTION

SCHEDULE						
SIZE	DEPTH	SPACE WIDTH	A' DIM	B' DIM	C' DIM	ONT DIM
9'x18'	18"	9'	13'	7'-6"	3'	4'-6"

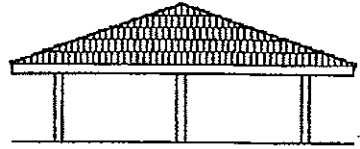

SIDE ELEVATION

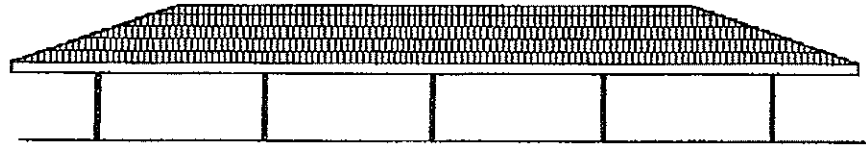

FRONT ELEVATION

<p><b>BAJA STANDARD</b></p> <p>HR-BB (HIP ROOF GABLE BACK TO BACK) CARPORTS</p>	<p><b>BAJA</b></p> <p>CONSTRUCTION CO., INC.</p> <p>223 FOSTER ST., MARTINEZ CA 94553</p> <p>1-800-366-9600 FAX: (925) 229-0161</p>	<p><b>SHEET</b></p> <p>Page <u>9</u> of <u>9</u></p>
---	---	--